

4

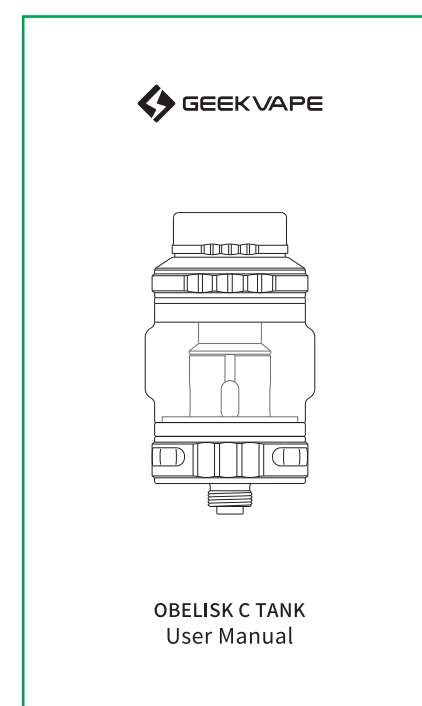

封面

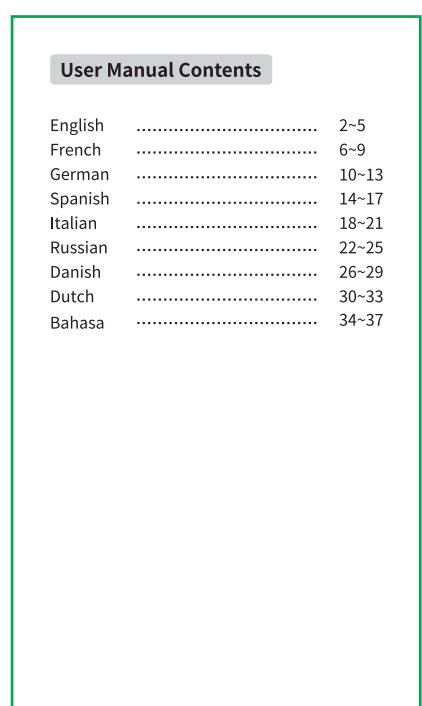

01 封一

英语

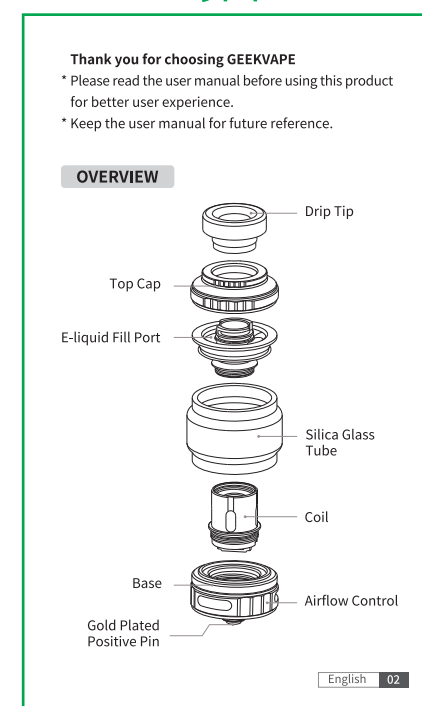

02

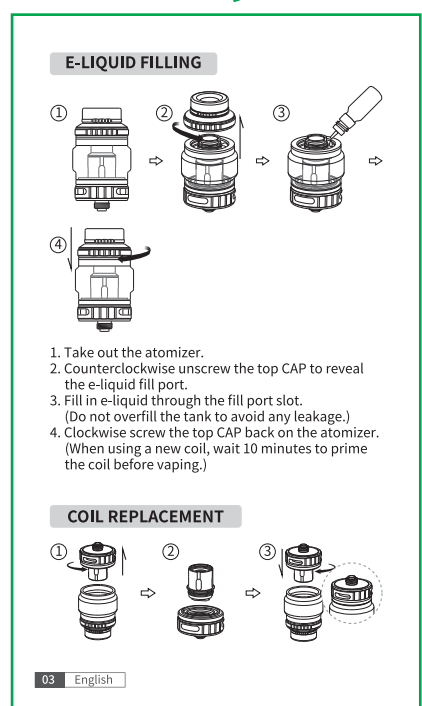

03

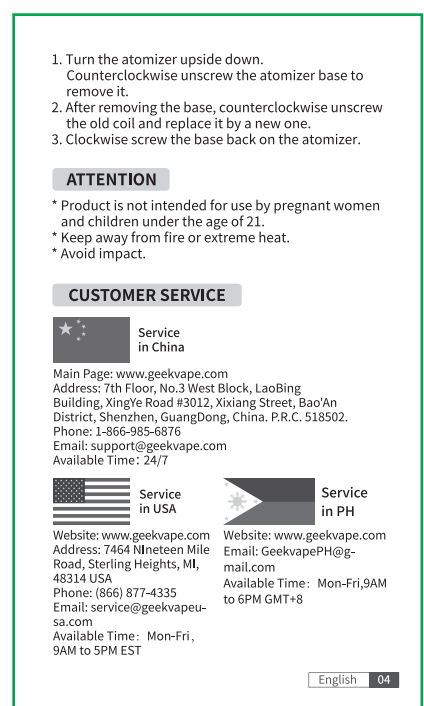

04

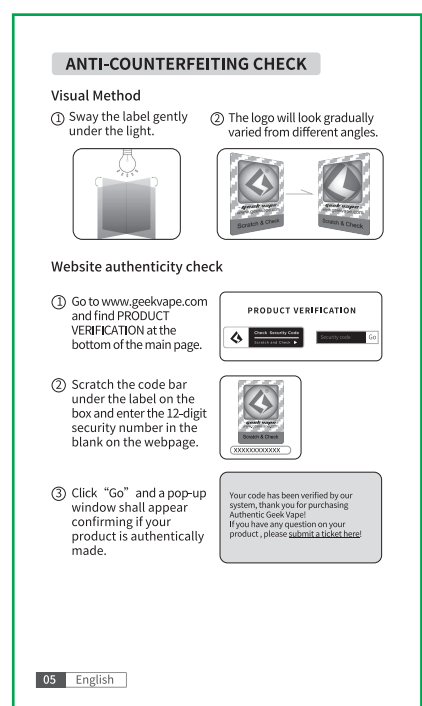

05

意大利

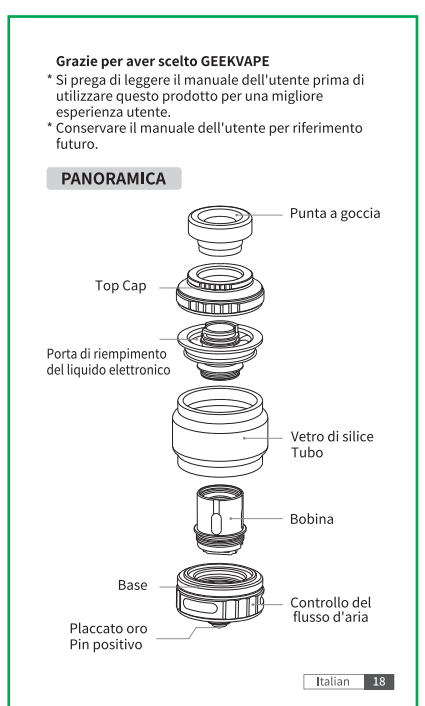

18

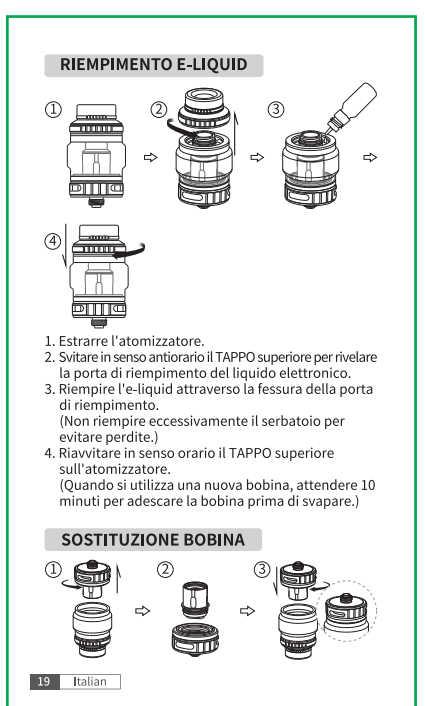

19



20

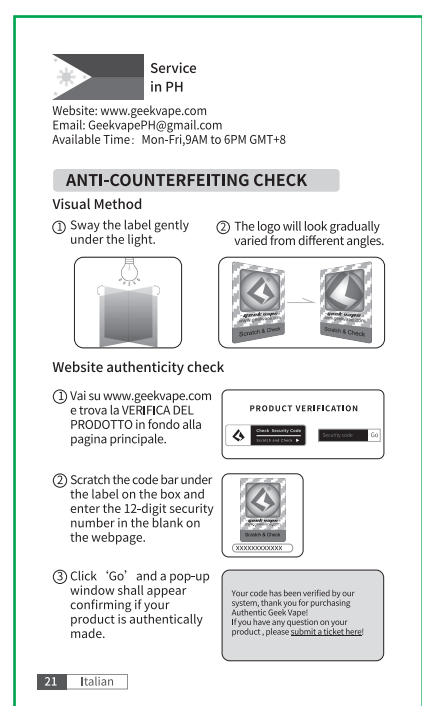

21

俄语



22



23



24

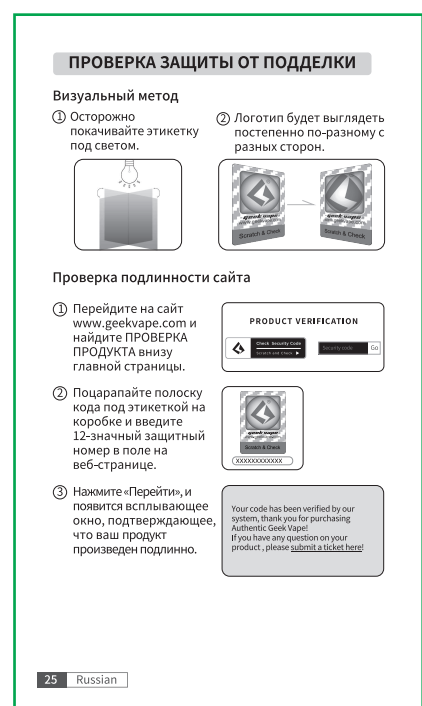

25

3

法语

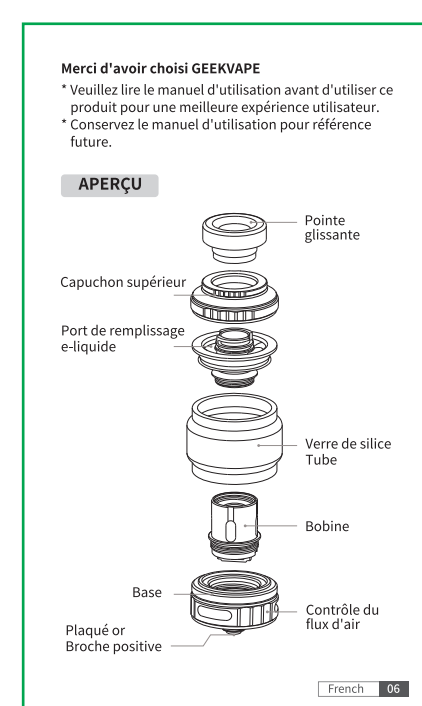

06

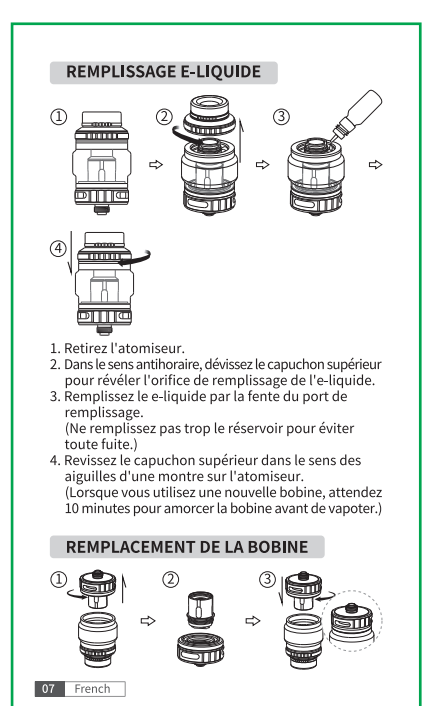

07

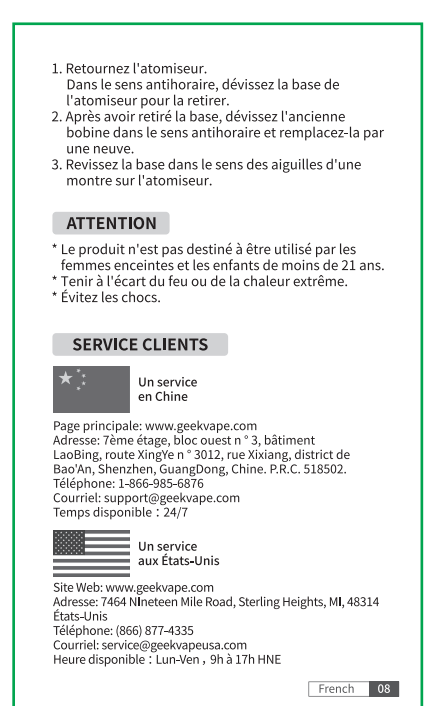

08

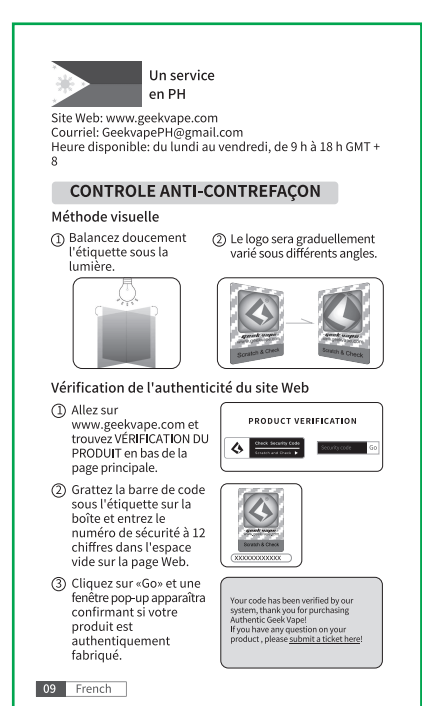

09

丹麦

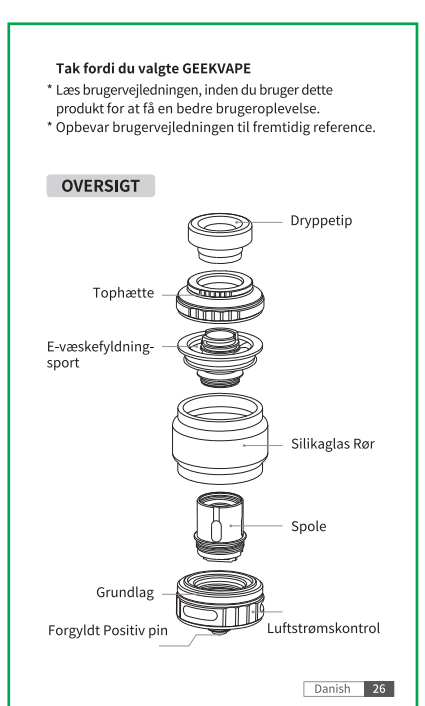

26

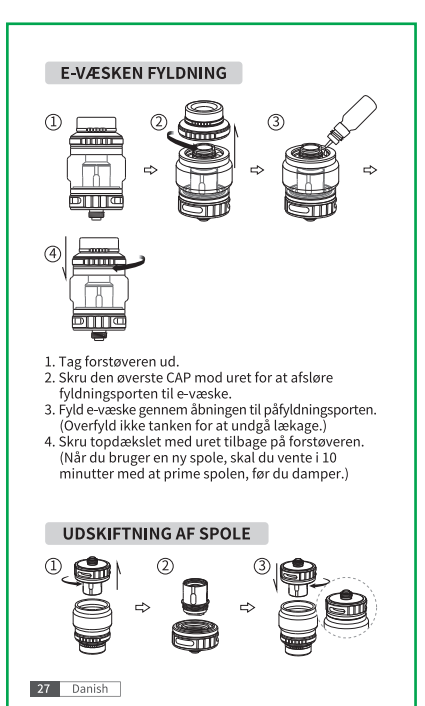

27

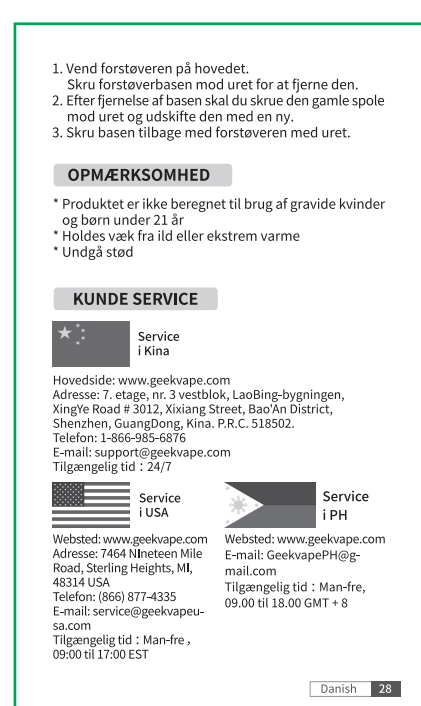

28



29

德语

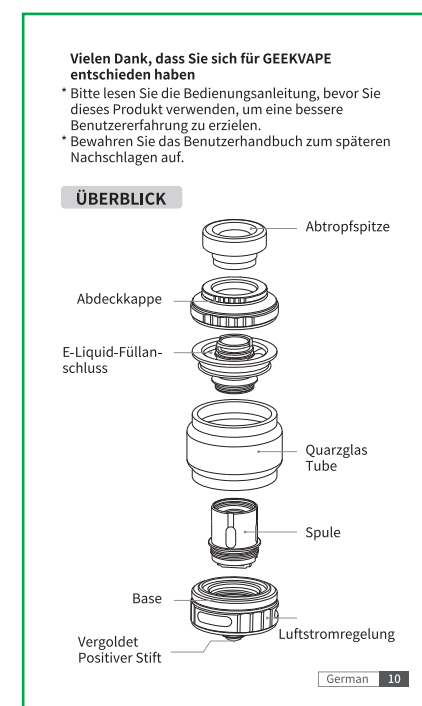

10

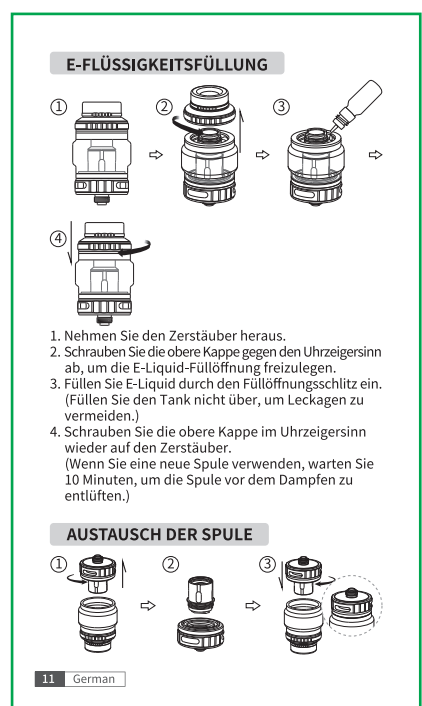

11



12

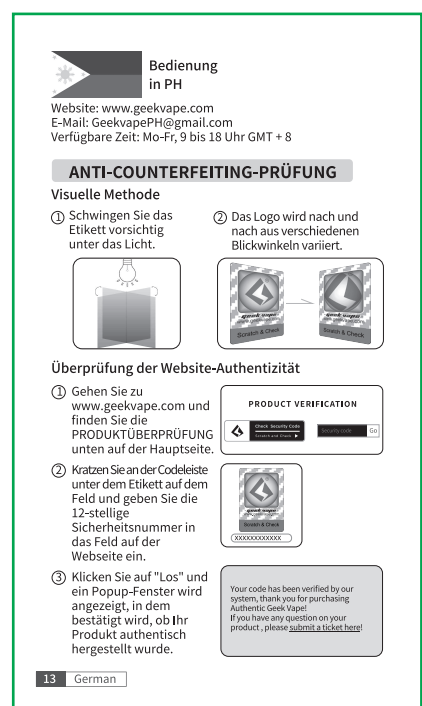

13

荷兰

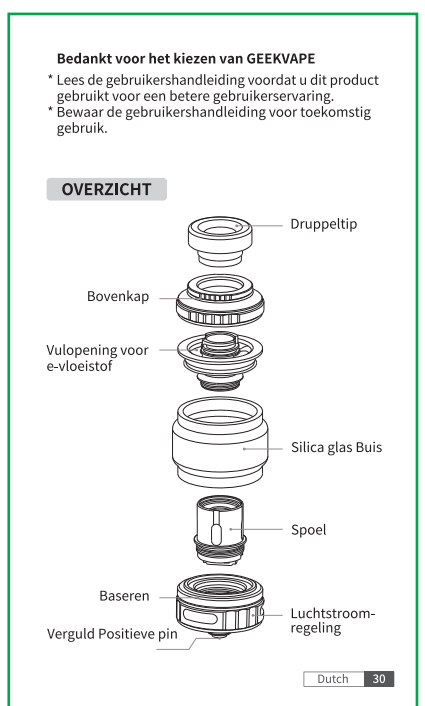

30



31



32

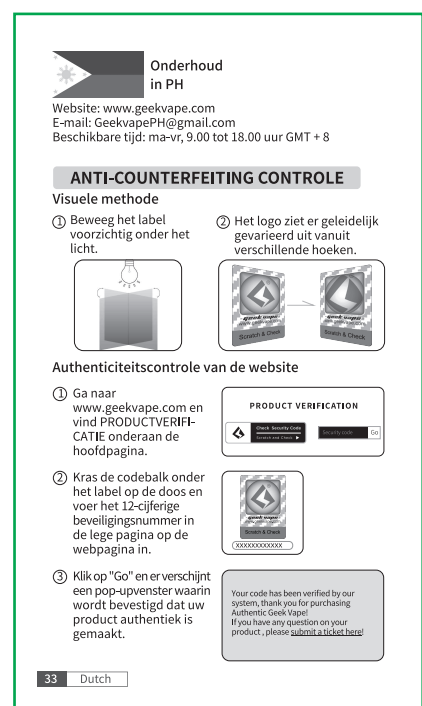

33

2

西班牙语

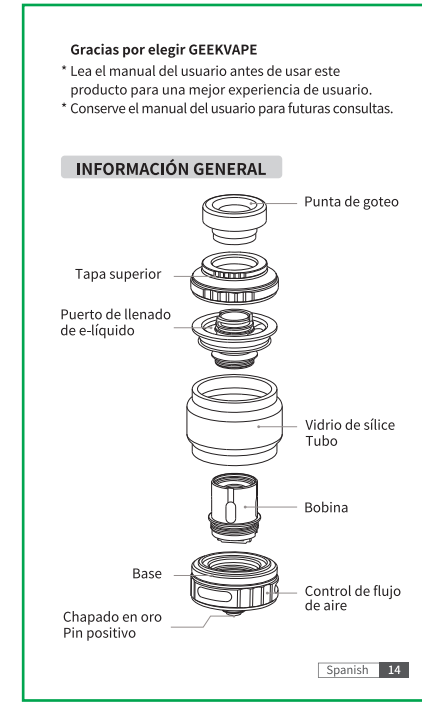

14

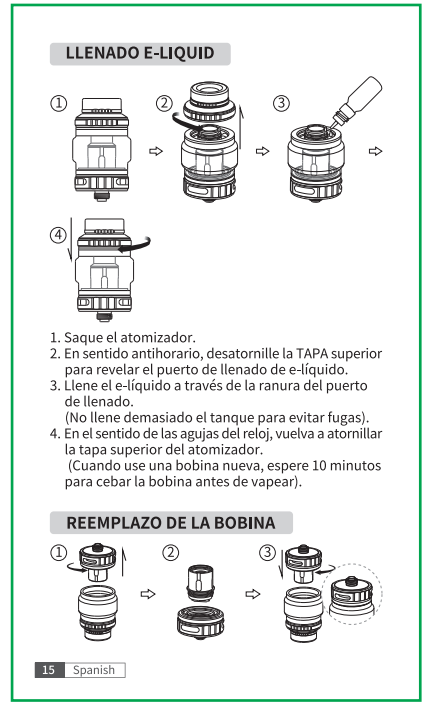

15



16

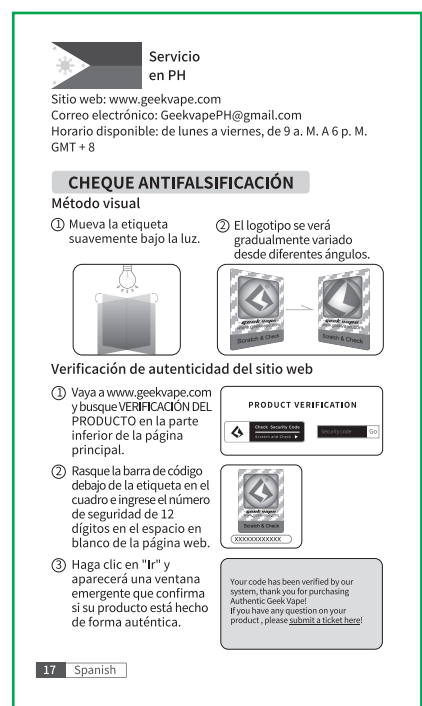

17

印尼



34



35



36



37



封二



封底

要求:

- 1. 材料: 80g书纸
- 2. 成品尺寸: 54*92mm ≤ 0.5
- 3. 工艺: 双面印刷, 骑马订装订。
- 4. 颜色: K, 色差ΔE ≤ 1.00;
- 5. 油墨, 要符合欧盟为RoHS环保标准。
- 6. 页码顺序依次按封面、封一、2...37、封二、封底印刷以文件为准, 严格按图纸做货。裁切边缘须整齐无毛边。



深圳市基克纳科技有限公司
Geekvape Technology co,LTD

绘图
PRODUCTNAME

魏鹏
2021/5/11

比例 1:1
SCALE

未标公差
OTHER TOLERANEC

产品名称
PRODUCTNAME

Obelisk C Tank - 试产说明书

审核
CHECKED

UNIT(单位): mm

产品编码
PART NO

GA0336

核准
APPROVED

REV(版本): A0.2

产品图号
PART NO

GA0336-P-S0-02

